



Ten top tips collection

Alfa Laval 360° Service Portfolio Extending Performance

Ten top tips to keep your Alfa Laval hygienic gasketed plate heat exchanger in tip top condition

- 1 Make sure that the operating conditions (temperature and flow rates) comply with the design specifications.
- 2 At start-up, vent the heat exchanger hot down and open the vessel slowly to avoid pressure surges and water hammer.
- 3 Use upstream strainers and protect the heat exchanger. Particulate fouling can protect the heat exchanger.
- 4 Check for any changes in temperature, pressure and air leaks of external leaks daily.
- 5 On a regular basis keep the gasketing balls clean and well lubricated.
- 6 Use condition monitoring techniques to avoid leaks to keep the plate heat exchanger in operation.
- 7 Use Cleaning in Place (CIP) to avoid the need to open the heat exchanger for cleaning.
- 8 Always keep strainers in units clean and dry. If a strainer is taken out of service, flush with water and clean it completely.
- 9 Protect heat exchangers from water splash.



Ten top tips to keep your Alfa Laval valve in tip top condition

- 1 Make regular service and maintenance on your Alfa Laval valves to be able to perform optimally. The most cost-effective approach is following our simple preventive maintenance programme which will prolong the lifespan of your Alfa Laval valves.
- 2 Use optimum air quality in operating the valves, i.e. avoiding dust, water and oil in the air system for a longer lifetime and service interval on the actuators.
- 3 Daily operate within temperature ranges specified in the instruction manual to ensure correct operation.
- 4 Follow the technical data during installation, operation and maintenance to ensure correct operation.
- 5 Regularly inspect your Alfa Laval valve for leaks to ensure your process is running efficiently.
- 6 Carefully monitor your cleaning process since the concentration of the cleaning solution can over time affect the rubber.
- 7 In order to ensure the longest possible lifetime for rubber seals it is essential to choose the right quality for the actual duty.
- 8 Always use Alfa Laval genuine spare parts which are designed for durability and performance.
- 9 For product wetted parts ensure lubrication with Paraflex GRE 700 or a similar approved grease, which makes maintaining your Alfa Laval valve easier.
- 10 Always keep Alfa Laval spare valve seals in stock to avoid unplanned downtime.



Ten top tips to keep your Alfa Laval tank equipment in tip top condition

- 1 Regularly monitor your Alfa Laval tank equipment. Keep your Alfa Laval tank equipment in good condition.
- 2 Follow our simple preventive maintenance programme to ensure your Alfa Laval tank equipment is in good condition.
- 3 Take into account that our complete maintenance programme is based on average operating conditions. If conditions are not according to Alfa Laval guidelines, it is recommended to service more often.
- 4 Always disassemble and assemble your Alfa Laval tank equipment according to Alfa Laval guidelines.
- 5 Always clean components prior to assembly to avoid dirt from your machinery.
- 6 Use only cleaning media as specified in the instruction manual.
- 7 Only operate with origins specified in the instruction manual to ensure smooth operation.



Ten top tips to keep your Alfa Laval rotary lobe pump in tip top condition

- 1 Make regular service and maintenance to ensure optimal performance.
- 2 Check mechanical seals and gearbox lipseals for leakage and replace when necessary.
- 3 Oil level in the gearbox should be checked regularly and replaced when necessary. Check the manual for re-lubrication intervals.
- 4 When checking pump suction and discharge pressures, it is advisable to install pressure gauges on both suction and discharge sides of the pump to spot any problems with the pump and/or equipment before they are resolved.
- 5 Follow the technical data during installation, operation and maintenance paying special attention to the warnings included in the documentation.
- 6 Always use Alfa Laval genuine spare parts which are designed for durability and performance.
- 7 Check to ensure that the Alfa Laval rotary lobe pump is operating in accordance with recommended parameters.
- 8 If design parameters change, e.g. capacity, speed, head, check in the Alfa Laval Configuration Kit if the pump is still suitable for the application.
- 9 Schedule preventive maintenance intervals to avoid unscheduled downtime and repair costs.
- 10 Wash Alfa Laval's 360° Service and Maintenance videos to learn how to do simple maintenance on your Alfa Laval rotary lobe pumps.



Ten top tips to keep your Alfa Laval LKH Pump in tip top condition

- 1 Make regular service and maintenance to be able to perform optimally.
- 2 Check the pump visually on a regular basis to ensure that you discover maintenance early when they are easy to solve.
- 3 Schedule preventive maintenance after 12 months to avoid unscheduled downtime and repair costs.
- 4 Check to ensure that the Alfa Laval LKH Pump is operating in accordance with recommended design parameters.
- 5 Observe the technical data during installation, operation and maintenance and pay special attention to the warnings included in the documentation.
- 6 Check to make sure water has been connected so that the shaft seal does not heat up. Dry running will damage the shaft seal and could lead to a damaged pump.
- 7 Always rinse well with clean water after using a cleaning agent.
- 8 If design parameters change, e.g. capacity, pressure, flow, check in the Alfa Laval Configuration Kit if the pump is still suitable for the application.
- 9 Always keep an Alfa Laval service kit in stock to avoid unplanned downtime.
- 10 Wash Alfa Laval's 360° Service and Maintenance videos to learn how to perform simple maintenance on your Alfa Laval LKH pumps.



Ten top reasons to use Alfa Laval genuine spare parts

- 1 Using Alfa Laval genuine spare parts will protect your Alfa Laval equipment because they are designed for maximum durability, productivity and low environmental impact.
- 2 Alfa Laval genuine spare parts are engineered to the highest standard and optimized to fit your Alfa Laval equipment.
- 3 Using Alfa Laval genuine spare parts will guarantee performance, reliability and optimum life for your Alfa Laval equipment.
- 4 Alfa Laval genuine spare parts provide assurance of continuous operation.
- 5 Non-genuine parts can increase the risk of unplanned downtime.
- 6 Each service kit contains all the spare parts needed.
- 7 Using Alfa Laval genuine spare parts ensures the lowest possible cost of ownership over the entire life cycle of your Alfa Laval equipment.
- 8 Alfa Laval genuine spare parts are commonly used in various industries and industry sectors, including pharmaceuticals, food and beverage, and pulp and paper.
- 9 Comprehensive documentation packages are available for Alfa Laval genuine spare parts. This ensures a smooth installation and adjustment process, and provides step-by-step instructions to avoid downtime.
- 10 Alfa Laval genuine spare parts are available around the clock through our extensive network of channel partners and distributor centers.



Extending performance with the Alfa Laval 360° Service Portfolio

Extending performance with the Alfa Laval 360° Service Portfolio

Extending performance with the Alfa Laval 360° Service Portfolio

Ten top tips

to keep your Alfa Laval hygienic gasketed plate heat exchanger in tip top condition

- 1 Make sure that the operating conditions (temperatures and flow rates) comply with the design specifications.
- 2 At start-up, vent the heat exchanger but open and close the valves slowly to avoid pressure surges and water hammer.
- 3 Use upstream filters and strainers to remove particulate fouling and protect the heat exchanger.
- 4 Check for any changes in temperature, pressure and any signs of external leaks daily.
- 5 On a regular basis keep the tightening bolts clean and well-lubricated.
- 6 Use condition monitoring techniques to avoid having to open the plate heat exchanger for inspection.



- 7 Use Cleaning-in-Place (CIP) to avoid the need to open the heat exchanger for cleaning.
- 8 Always keep stand-by units clean and dry. If a heat exchanger is taken out of service, flush with fresh water and drain it completely.
- 9 Protect heat exchangers from water splash. Avoid exposure to ultra violet rays and ozone typically generated from electrical sources.
- 10 Only use Alfa Laval genuine spare parts for guaranteed performance, reliability and equipment life. Maintain a stock of essential spare parts and follow the storage instructions.

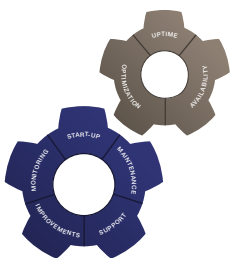

Extending performance
with the Alfa Laval 360° Service Portfolio



Ten top tips

to keep your Alfa Laval valve in tip top condition

- 1 Make regular service and maintenance on your Alfa Laval valves for them to be able to perform optimally. The most cost-effective approach is following our simple preventive maintenance programme which will prolong the lifespan of your Alfa Laval valves.
- 2 Use optimum air quality in operating the valves, i.e. avoiding dust, water and oil in the air system for a longer lifetime and service interval on the actuators.
- 3 Only operate within temperature ranges specified in the instruction manual to ensure smooth operation.
- 4 Follow the technical data during installation, operation and maintenance to ensure correct operation.
- 5 Regularly inspect your Alfa Laval valve for leakage to ensure your process is running efficiently.



- 6 Carefully monitor your cleaning process since the composition of the cleaning solution can over time affect the rubber.
- 7 In order to ensure the longest possible lifetime for rubber seals it is essential to choose the right quality for the actual duty.
- 8 Always use Alfa Laval genuine spare parts which are designed for durability and performance.
- 9 For product wetted parts ensure lubrication with Paraliq GTE 703 or a similar approved grease which makes maintaining your Alfa Laval valve easier.
- 10 Always keep Alfa Laval spare rubber seals in stock to avoid unplanned downtime.

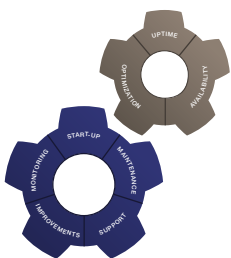

Extending performance
with the Alfa Laval 360° Service Portfolio



Ten top tips

to keep your Alfa Laval rotary lobe pump in tip top condition

- 1 Make regular service and maintenance to ensure optimal performance.
- 2 Check mechanical seals and gearbox lipseals for leakage and replace when necessary.
- 3 Oil level in the gearbox should be checked regularly and re-filled when necessary. Check the manual for re-lubrication schedule.
- 4 When checking pump suction and discharge pressures, it is advisable to install pressure gauges on both suction and discharge sides of the pump so that any problems within the pump and/or pipework system can be monitored.
- 5 Follow the technical data during installation, operation and maintenance paying special attention to the warnings indicated in the documentation.



- 6 Always use Alfa Laval genuine spare parts which are designed for durability and performance.
- 7 Check to ensure that the Alfa Laval rotary lobe pump is operating in accordance with recommended design parameters.
- 8 If design parameters change, e.g. capacity/pressure/new liquid, check in the Alfa Laval Configurator or with Alfa Laval if the pump is still suitable for the application.
- 9 Schedule preventative maintenance after 12 months to avoid unscheduled downtime and maximize lifetime and value.
- 10 Watch Alfa Laval's 360° Service and Maintenance videos to learn how to do simple maintenance on your Alfa Laval rotary lobe pumps.

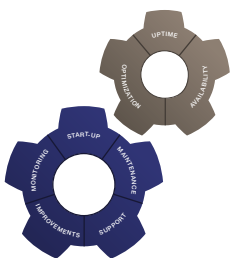

Extending performance
with the Alfa Laval 360° Service Portfolio



Ten top tips

to keep your Alfa Laval tank equipment in tip top condition

- 1 Regularly maintain your Alfa Laval tank equipment following scheduled service intervals. This will always keep your Alfa Laval tank equipment in good condition.
- 2 Follow our simple preventive maintenance to prolong the lifespan of your Alfa Laval tank equipment.
- 3 Take into account that our preventive maintenance programme is based on average operating conditions. If you are operating your Alfa Laval equipment under hard conditions, it is recommended to service more often.
- 4 Always disassemble and assemble your Alfa Laval tank equipment according to Alfa Laval guidelines.
- 5 Always clean components prior to assembly to avoid extra wear on your machine parts.
- 6 Use only cleaning media as specified in the instruction manual.



- 7 Only operate within ranges specified in the instruction manual to ensure smooth operation.
- 8 After use, flush your Alfa Laval tank equipment with fresh water. Cleaning solutions should never be allowed to dry or set-up in the system due to possible "salting out" or "scaling" of the cleaning ingredient.
- 9 Always keep an Alfa Laval service kit in stock to avoid unplanned downtime.
- 10 Always fill in an Alfa Laval service card to register the maintenance carried out so that you can easily document the service history on your Alfa Laval tank equipment.

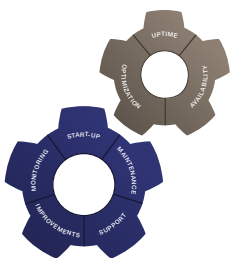

Extending performance
with the Alfa Laval 360° Service Portfolio



Ten top tips

to keep your Alfa Laval LKH Pump in tip top condition

- 1 Make regular service and maintenance to be able to perform optimally.
- 2 Check the pump visually on a regular basis to ensure that you discover maintenance needs early when they are easy to solve.
- 3 Schedule preventative maintenance after 12 months to avoid unscheduled downtime and to maximize lifetime and value.
- 4 Check to ensure that the Alfa Laval LKH Pump is operating in accordance with recommended design parameters.
- 5 Observe the technical data during installation, operation and maintenance and pay special attention to the warnings indicated in the documentation!
- 6 Check to make sure water has been connected so that the shaft seal does not run dry. Dry running will damage the shaft seal and could lead to a damaged pump.

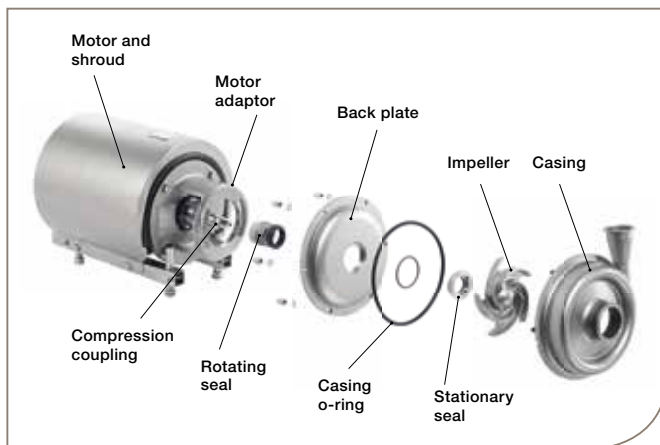

- 7 Always rinse well with clean water after using a cleaning agent.
- 8 If design parameters change, e.g. capacity/pressure/new liquid check in the Alfa Laval Configurator or with Alfa Laval if the pump is still suitable for the application.
- 9 Always keep an Alfa Laval service kit in stock to avoid unplanned downtime.
- 10 Watch Alfa Laval's 360° Service and Maintenance videos to learn how to perform simple maintenance on your Alfa Laval LKH pumps.

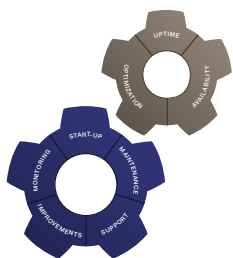

Extending performance
with the Alfa Laval 360° Service Portfolio



Ten top reasons

to use Alfa Laval genuine spare parts

- 1 Using Alfa Laval genuine spare parts will protect your Alfa Laval equipment because they are designed and manufactured for durability, productivity, and less environmental impact.
- 2 All Alfa Laval genuine spare parts are engineered to the highest standard and optimized to fit your product and application.
- 3 Using Alfa Laval genuine spare parts will guarantee performance, reliability and equipment life.
- 4 Alfa Laval genuine spare parts provide assurance of continuous operation.
- 5 Non-genuine parts can increase the risk of unplanned downtime.
- 6 Each service kit contains all the spare parts you need.



- 7 Using Alfa Laval genuine spare parts ensures the lowest possible total cost of ownership over the entire life cycle of your quality Alfa Laval equipment.
- 8 Alfa Laval genuine spare parts are continuously improved to meet the highest demands expressed in various legislation and industry specific standards such as, FDA, EU-regulations, 3-A, EHEDG, ASME BPE, etc.
- 9 Comprehensive documentation packages are available for Alfa Laval genuine spare parts. This ensures a smooth qualification and validation process, and provides long-term peace of mind.
- 10 Alfa Laval genuine spare parts are available around the clock through our extensive network of channel partners and distribution centres.

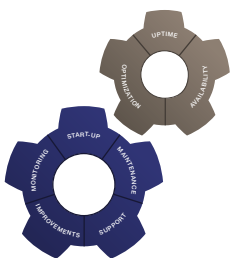

Extending performance
with the Alfa Laval 360° Service Portfolio



Alfa Laval in brief

Alfa Laval is a leading global provider of specialized products and engineered solutions.

Our equipment, systems and services are dedicated to helping customers to optimize the performance of their processes. Time and time again.

We help our customers to heat, cool, separate and transport products such as oil, water, chemicals, beverages, foodstuff, starch and pharmaceuticals.

Our worldwide organization works closely with customers in almost 100 countries to help them stay ahead.

How to contact Alfa Laval

Up-to-date Alfa Laval contact details for all countries are always available on our website at www.alfalaval.com